

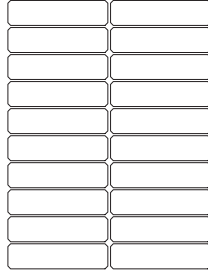

RAFFINATO 90 & 180 mm

DESCRIPTION: Wall **TEXTURE:** Polished (on a single-side only)

PALLET OVERVIEW - 90 mm



Specifications per pallet		Imperial	Metric
90 mm	Cubing	23.08 ft²	2.14 m ²
		78.15 lin ft	23.82 lin m
	Approx. Weight	1 948 lbs	884 kg
	Minimum radius	8.5 ft	2.6 m
	Number of rows	3	
	Coverage per row	7.69 ft ²	0.71 m ²
	Linear coverage per row	26.05 lin ft	7.94 lin m

PALLET OVERVIEW - 180 mm

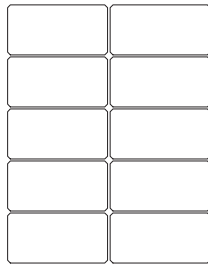

Unit dimensions		in	mm	Units/pallet
	Height	3 ⁹ / ₁₆	90	60 units
	Depth	9 ³ / ₄	248	
	Length 1	15 ⁵ / ₈	397	
	Length 2	14 ¹ / ₄	362	

Specifications per pallet		Imperial	Metric
180 mm	Cubing	23.08 ft²	2.14 m ²
		39.07 lin ft	11.91 lin m
	Approx. Weight	1 936 lbs	878 kg
	Minimum radius	8.5 ft	2.6 m
	Number of rows	3	
	Coverage per row	7.69 ft ²	0.71 m ²
Linear coverage per row	13.02 lin ft	3.97 lin m	

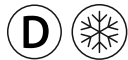

COMPATIBLE CAPS

See page 137 for product compatibility.

NOTES

Polished only on one side, Smooth on the other side.

See page 138 to 153 for more technical information.

Polished is made-to-order, minimum order of 500 sq. ft. Deposit required.

*Shale Grey is available in Canada only.

Unit dimensions		in	mm	Units/pallet
	Height	7 ¹ / ₁₆	180	30 units
	Depth	9 ³ / ₄	248	
	Length 1	15 ⁵ / ₈	397	
	Length 2	14 ¹ / ₄	362	





RAFFINATO 90 & 180 mm

DESCRIPTION: Wall double-sided TEXTURE: Smooth

PALLET OVERVIEW 90 mm & 180 mm

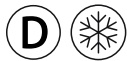
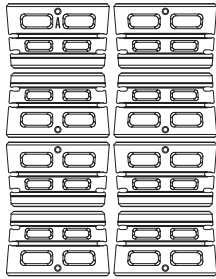

COMPATIBLE CAPS

See page 137 for product compatibility.

NOTES

When building a double-sided wall one pallet will cover an average of 23.53 ft².

See page 138 to 153 for more technical information.

*Shale Grey is available in Canada only.

Specifications per pallet		Imperial	Metric
90 mm	Cubing	24.61 ft²	2.29 m ²
		83.36 lin. ft	25.41 lin. m
	Approx. Weight	2 060 lbs	934 kg
	Minimum radius	8.5 ft	2.6 m
	Number of rows	8	
	Coverage per row	3.08 ft ²	0.29 m ²
	Linear coverage per row	10.42 lin. ft	3.18 lin. m



Unit dimensions	in	mm	Units/pallet
Height	3 ⁹ / ₁₆	90	64 units
Depth	9 ¹³ / ₁₆	249	
Length 1	15 ⁵ / ₈	397	
Length 2	14 ¹ / ₄	362	

Specifications per pallet		Imperial	Metric
180 mm	Cubing	24.61 ft²	2.29 m ²
		41.68 lin. ft	12.70 lin. m
	Approx. Weight	2 071 lbs	939 kg
	Minimum radius	8.5 ft	2.6 m
	Number of rows	4	
	Coverage per row	6.15 ft ²	0.57 m ²
	Linear coverage per row	10.42 lin. ft	3.18 lin. m



Unit dimensions	in	mm	Units/pallet
Height	7 ¹ / ₁₆	180	32 units
Depth	9 ¹³ / ₁₆	249	
Length 1	15 ⁵ / ₈	397	
Length 2	14 ¹ / ₄	362	

Beige Cream

Smooth



Greyed Nickel

Smooth



Shale Grey*

Smooth



Onyx Black

Smooth

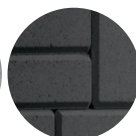



RAFFINATO 90 & 180 mm

DESCRIPTION: Pillars, corners and edges **TEXTURE:** Polished (on a single-side only)

PALLET OVERVIEW - 90 mm

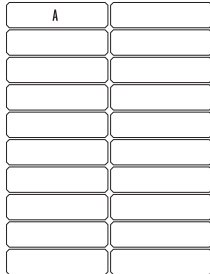

PALLET OVERVIEW - 180 mm

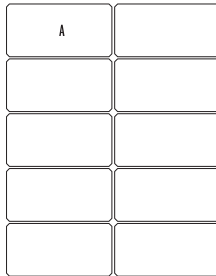

Specifications per pallet		Imperial	Metric
90 mm	Cubing	40 units	40 units
	Approx. Weight	1 559 lbs	707 kg
	Number of rows	2	
	Pillar height	35 7/16"	900 mm



A



Unit dimensions	in	mm	Units/pallet
Height	3 7/16	90	40 units
Depth	9 3/4	248	
Length	14 1/16	357	

Specifications per pallet		Imperial	Metric
180 mm	Cubing	20 units	20 units
	Approx. Weight	1 557 lbs	706 kg
	Number of rows	2	
	Pillar height	35 7/16"	900 mm



A



Unit dimensions	in	mm	Units/pallet
Height	7 1/16	180	20 units
Depth	9 3/4	248	
Length	14 1/16	357	

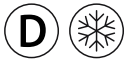

COMPATIBLE CAPS

See page 137 for product compatibility.

NOTES

Polished only on one side, Smooth on the other side.

See page 138 to 153 for more technical information.

Polished is made-to-order, minimum order of 500 sq. ft. Deposit required.

*Shale Grey is available in Canada only.





RAFFINATO 90 & 180 mm

DESCRIPTION: Pillars, corners and edges **TEXTURE:** Smooth

PALLET OVERVIEW - 90 mm

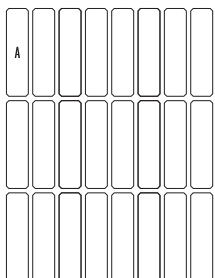

PALLET OVERVIEW - 180 mm

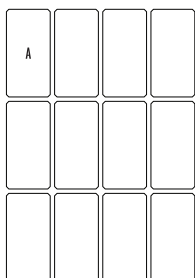

Specifications per pallet		Imperial	Metric
90 mm	Cubing	48 units	48 units
	Approx. Weight	1 548 lbs	702 kg
	Number of rows	2	
	Pillar height	42 ½ in	1 080 mm

Unit dimensions		in	mm	Units/pallet
	Height	3 ⅞	90	48 units
	Depth	9 ⅓	249	
	Length	14 ⅛	359	

Specifications per pallet		Imperial	Metric
180 mm	Cubing	24 units	24 units
	Approx. Weight	1 529 lbs	694 kg
	Number of rows	2	
	Pillar height	42 ½ in	1 080 mm

Unit dimensions		in	mm	Units/pallet
	Height	7 ⅞	180	24 units
	Depth	9 ⅓	249	
	Length	14 ⅛	359	



COMPATIBLE CAPS

See page 137 for product compatibility.

NOTES

See page 138 to 153 for more technical information.

*Shale Grey is available in Canada only.

Beige Cream

Smooth



Greyed Nickel

Smooth



Shale Grey*

Smooth



Onyx Black

Smooth



CLEAN SAND/GRAVEL/ SAND AND GRAVEL MIXES ($\phi=34^\circ$, $\gamma = 120$ pcf)
GEOGRID: MIRAGRID 3XT BY TENCATE (RFd=1.10, RFcr=1.45, RFid=1.25, Cds=0.9, Ci=0.9)

CASE N° 1 :
No Surcharge
No Backslope
No Toe Slope

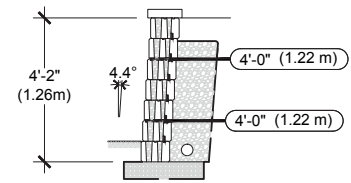
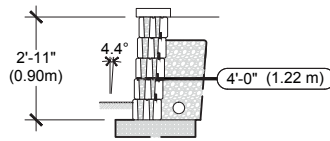
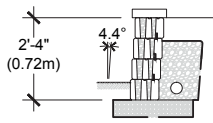

VISIT WWW.TECHO-BLOC.COM FOR COMPLETE DESIGN CHART DOCUMENT
(USA AND CANADA VERSIONS)

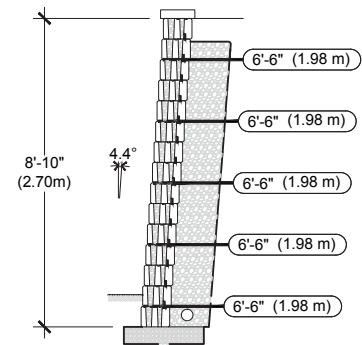
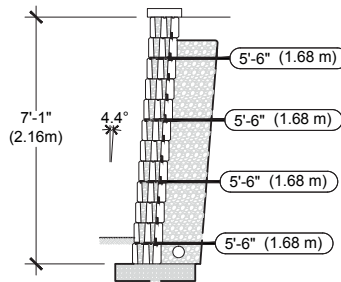
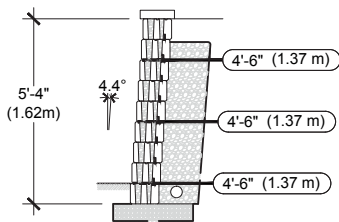

- The information contained in the design charts is supplied for information purposes only and as such should only be used for preliminary designs.
- The height (H) of the wall is the total height from the leveling pad to the top of the wall not including the thickness of the cap.
- Soil parameters: reinforced soil ($\phi = 34^\circ$, $\gamma = 120$ pcf); retained soil ($\phi = 34^\circ$, $\gamma = 120$ pcf); foundation soil ($\phi = 34^\circ$, $\gamma = 120$ pcf)
- A qualified engineer should be consulted for the final design to be used for construction.
- The foundation soil must be able to support the wall system. The bearing capacity of the foundation soil, settlement, and global stability must be verified and validated by a qualified geotechnical engineer.
- The seismic analysis is not included.
- The design charts do not apply to tiered walls.
- The charts assume that the walls are constructed in accordance with Techo-Bloc specifications, good construction practice and an adequate drainage system.
- The geogrid layout has been optimized to satisfy the design requirements of the NCMA's Design Manual for Segmental Retaining Walls, 3rd Edition.
- The minimum burial depth must be 6 in (150 mm) or 10% of the exposed height, whichever is greater.
- Engineering judgement should be used when interpolating between heights.
- Techo-Bloc and its predecessors, successors, beneficiaries, employees, associates, administrators and insurers accepts no liability for the incorrect use of information contained in the design charts.
- For further information, please contact our technical service department.

INSTALLATION GUIDE

RETAINING WALLS - RAFFINATO 90 mm & 180 mm

1-Row Pattern | Laying Patterns

The single row model shows two examples combination. Each combination is 2.4 m (7.87") long and 180 mm (7 1/16") high. **This model can be used for installing the last row of modules or where other models cannot be used.**

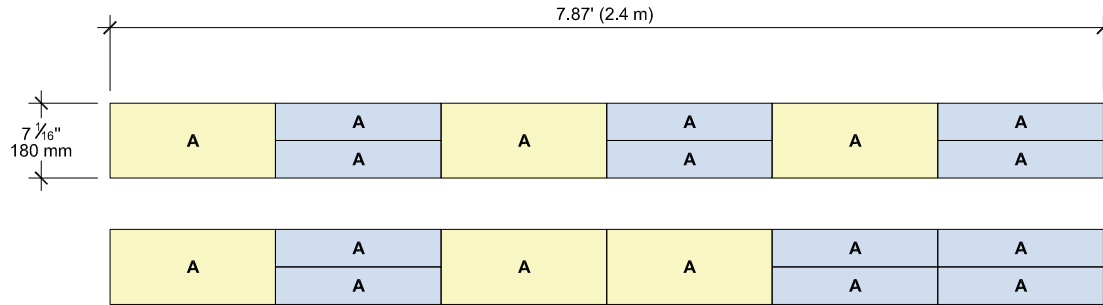

NUMBER OF BLOCKS REQUIRED MODULE

RAFFINATO	A
50 % of the surface - Raffinato 90 mm	6
50 % of the surface - Raffinato 180 mm	3

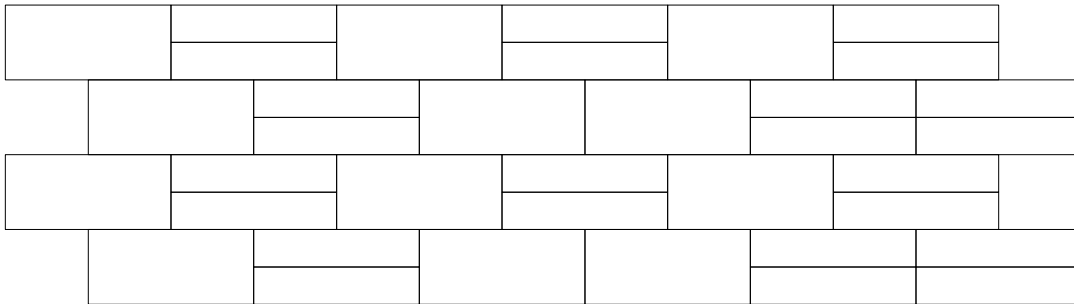

INSTALLATION GUIDE

RETAINING WALLS - RAFFINATO 90 mm & 180 mm

3-Row Pattern | Laying Patterns

The 3-row model is 2.4 m (7.87') long and 540 mm (21 1/4") high. This model allows for a graded area at every 540 mm (21 1/4"), which corresponds to the recommended spacing between the layers of geogrid in a Raffinato wall. **This model is recommended when using geogrid.**

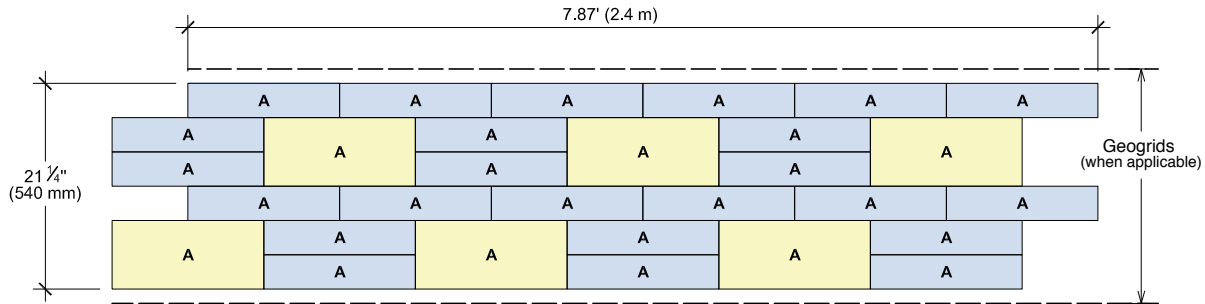

NUMBER OF BLOCKS REQUIRED MODULE

RAFFINATO	A
67 % of the surface - Raffinato 90 mm	24
33 % of the surface - Raffinato 180 mm	6

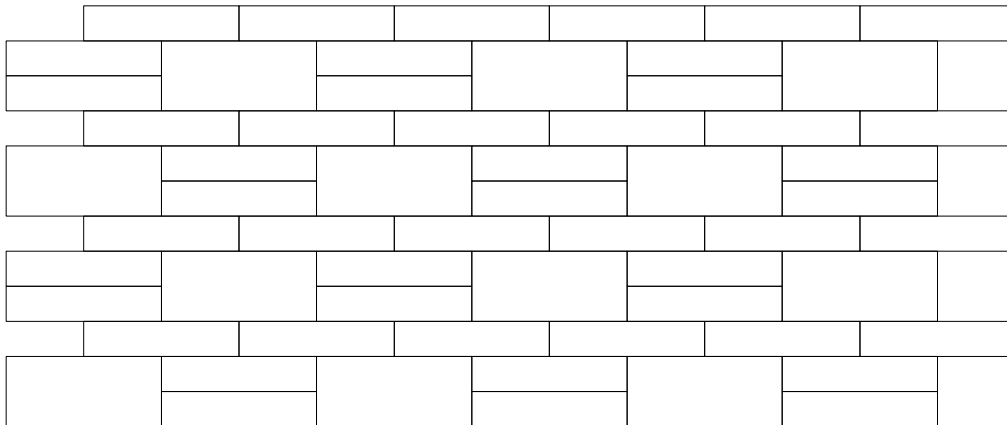

INSTALLATION GUIDE

RETAINING WALLS - RAFFINATO 90 mm & 180 mm

4-Row Pattern | Laying Patterns

The 4-row model shows two combination examples. This combination is 2.4 m (7,87') long and 720 mm (28 3/8") high. **This model should only be used where geogrid is not required.**

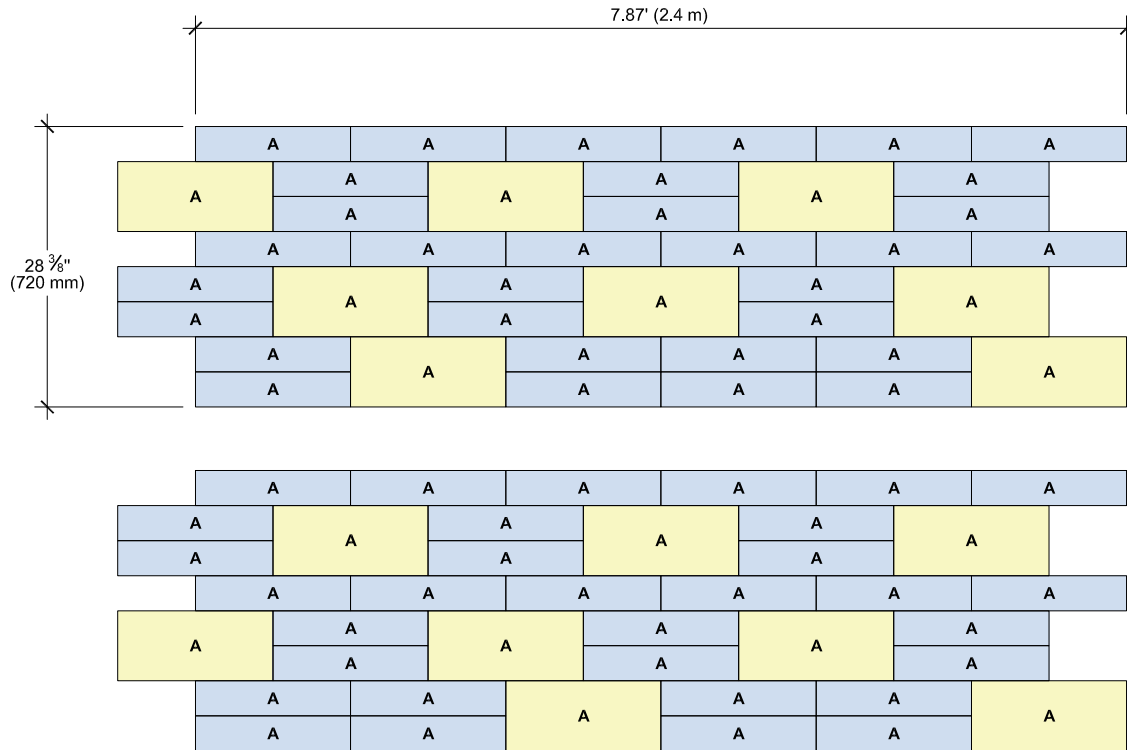

NUMBER OF BLOCKS REQUIRED MODULE

RAFFINATO	A
67 % of the surface - Raffinato 90 mm	32
33 % of the surface - Raffinato 180 mm	8

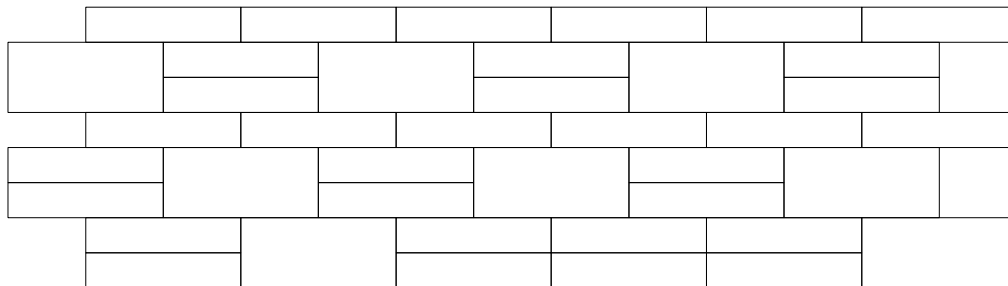

INSTALLATION GUIDE

FREESTANDING WALLS - RAFFINATO 90 mm & 180 mm

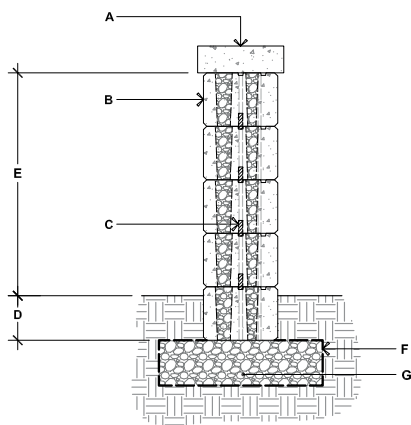

RAFFINATO 90 mm & 180 mm

- A.** TECO-BLOC CAP UNIT SECURED TO UNIT BELOW WITH FLEXLOCK ADHESIVE
- B.** RAFFINATO 90 mm AND 180 mm DOUBLE-SIDED WALL UNITS SECURE EACH ROW WITH FLEXLOCK ADHESIVE
- C.** CONNECTOR
- D.** EMBEDMENT DEPTH, 6" (150 mm) MIN.
- E.** 29 7/16" (750 mm) MAX.
- F.** GEOTEXTILE
- G.** COMPACTED GRANULAR LEVELING PAD, 6" (150 mm) THICK MIN. THICKNESS ACCORDING TO PROJECT SPECIFIC CONDITIONS

90° CORNER OF A DOUBLE-SIDED WALL

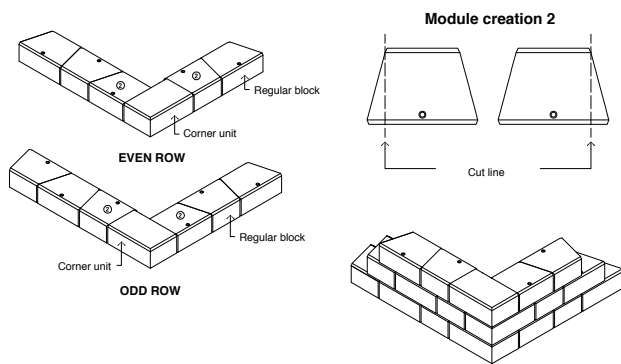

DOUBLE-SIDED WALL RADIUS

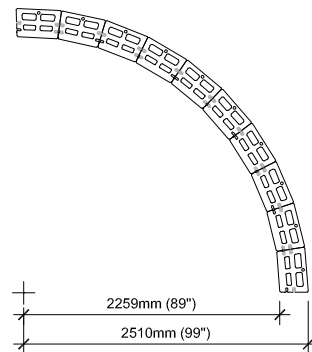

It is the user's responsibility to verify for the quantity of materials required.

DOUBLE SIDED WALL - END OF A STRAIGHT WALL

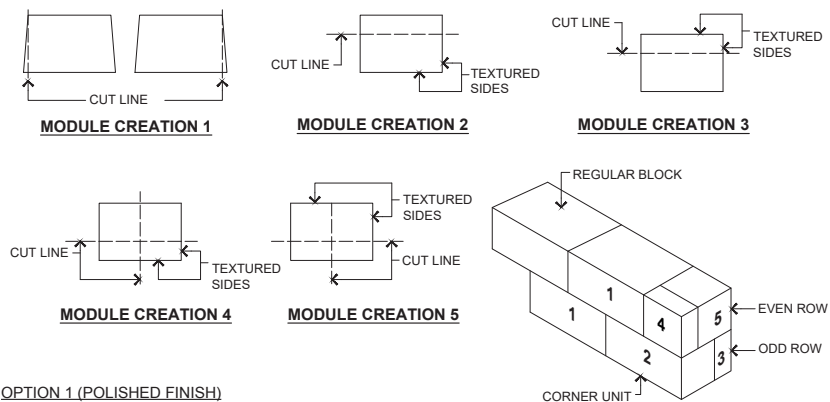

GENERAL NOTES

1. Alternate odd and even rows.
2. Stagger joints from one row to the next.
3. Glue all modules at each row with Flexlock adhesive.
4. Cavities, grooves and connectors are not illustrated to avoid overloading the image.

OPTION 1 (POLISHED FINISH)

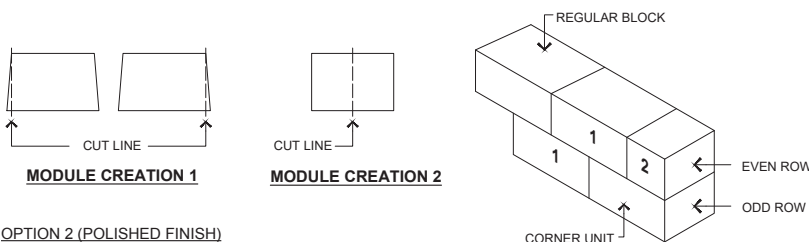

OPTION 2 (POLISHED FINISH)

PLEASE REFER TO P.4 FOR THE CORRECT USE AND LIMITATIONS OF PROVIDED TECHNICAL INFORMATION.

INSTALLATION GUIDE

PILLARS - RAFFINATO 90 mm & 180 mm

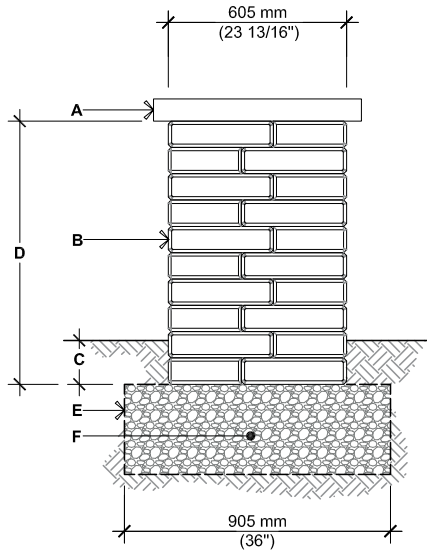

RAFFINATO 90 mm

- A.** STONEDGE COLLECTION PILLAR CAP UNIT, SECURE TO UNITS BELOW WITH FLEXLOCK ADHESIVE
- B.** RAFFINATO 90 mm PILLAR UNIT SECURE EACH ROW WITH FLEXLOCK ADHESIVE
- C.** EMBEDMENT DEPTH: 150 mm (6") MIN.
- D.** 1 080 mm (42 ½"), MAXIMUM HEIGHT
- E.** GEOTEXTILE
- F.** COMPACTED GRANULAR BASE 150 mm (6") THICK MIN. THICKNESS ACCORDING TO PROJECT SPECIFIC CONDITIONS

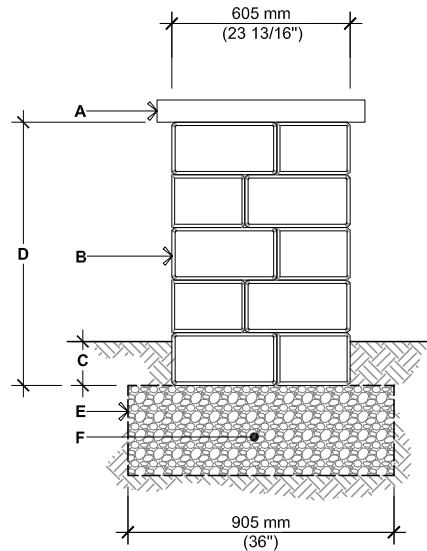

RAFFINATO 180 mm

- A.** STONEDGE COLLECTION PILLAR CAP UNIT, SECURE TO UNITS BELOW WITH FLEXLOCK ADHESIVE
- B.** RAFFINATO 180 mm PILLAR UNIT SECURE EACH ROW WITH FLEXLOCK ADHESIVE
- C.** EMBEDMENT DEPTH: 150 mm (6") MIN.
- D.** 1080 mm (42 ½"), MAXIMUM HEIGHT
- E.** GEOTEXTILE
- F.** COMPACTED GRANULAR BASE 150 mm (6") THICK MIN. THICKNESS ACCORDING TO PROJECT SPECIFIC CONDITIONS

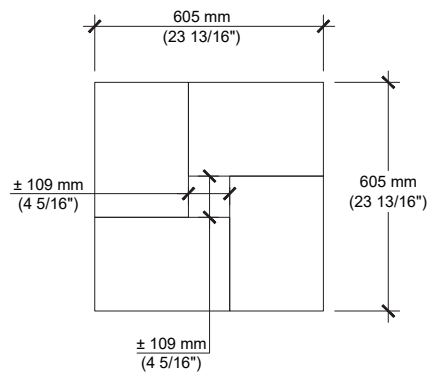

For all possible combinations of pillars and caps, please refer to the correspondence table on page 137

INSTALLATION GUIDE

PILLARS - RAFFINATO 90 mm & 180 mm

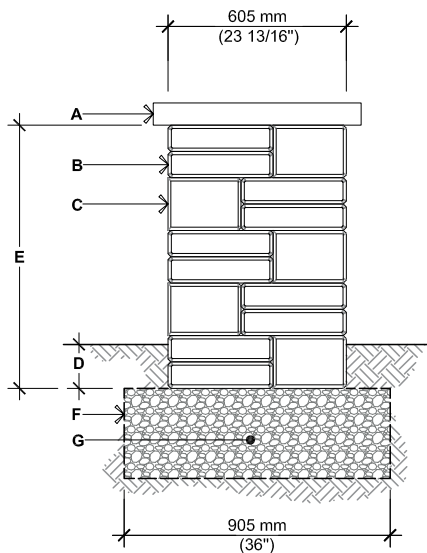

RAFFINATO 90 mm & 180 mm
OPTION A

- A.** STONEDGE COLLECTION PILLAR CAP UNIT, SECURE TO UNITS BELOW WITH FLEXLOCK ADHESIVE
- B.** RAFFINATO 90 mm PILLAR UNIT SECURE EACH ROW WITH FLEXLOCK ADHESIVE
- C.** RAFFINATO 180 mm PILLAR UNIT SECURE EACH ROW WITH FLEXLOCK ADHESIVE
- D.** EMBEDMENT DEPTH: 150 mm (6") MIN.
- E.** 1 080 mm (42 1/2"), MAXIMUM HEIGHT
- F.** GEOTEXTILE
- G.** COMPACTED GRANULAR BASE 150 mm (6") THICK MIN. THICKNESS ACCORDING TO PROJECT SPECIFIC CONDITIONS

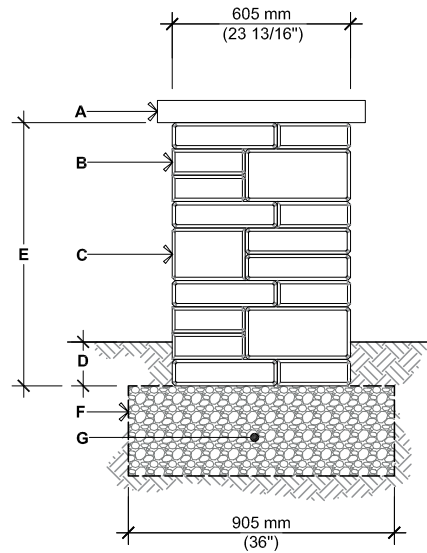

RAFFINATO 90 mm & 180 mm
OPTION B

- A.** STONEDGE COLLECTION PILLAR CAP UNIT, SECURE TO UNITS BELOW WITH FLEXLOCK ADHESIVE
- B.** RAFFINATO 90 mm PILLAR UNIT SECURE EACH ROW WITH FLEXLOCK ADHESIVE
- C.** RAFFINATO 180 mm PILLAR UNIT SECURE EACH ROW WITH FLEXLOCK ADHESIVE
- D.** EMBEDMENT DEPTH: 150 mm (6") MIN.
- E.** 1 080 mm (42 1/2"), MAXIMUM HEIGHT
- F.** GEOTEXTILE
- G.** COMPACTED GRANULAR BASE 150 mm (6") THICK MIN. THICKNESS ACCORDING TO PROJECT SPECIFIC CONDITIONS

STEPS

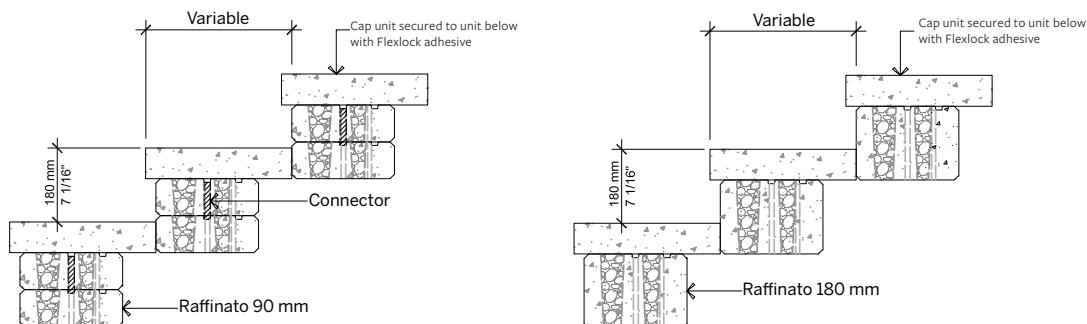

For all possible combinations of pillars and caps, please refer to the correspondence table on page 137

PLEASE REFER TO P.4 FOR THE CORRECT USE AND LIMITATIONS OF PROVIDED TECHNICAL INFORMATION.

INSTALLATION GUIDE

GRILL ISLAND - RAFFINATO SMOOTH 90 mm & 180 mm

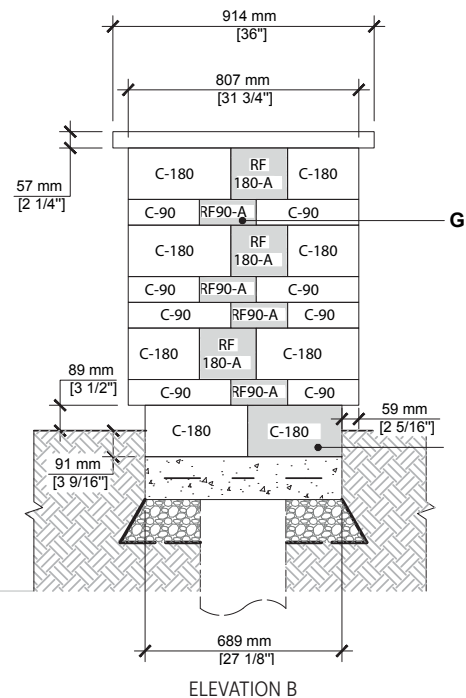
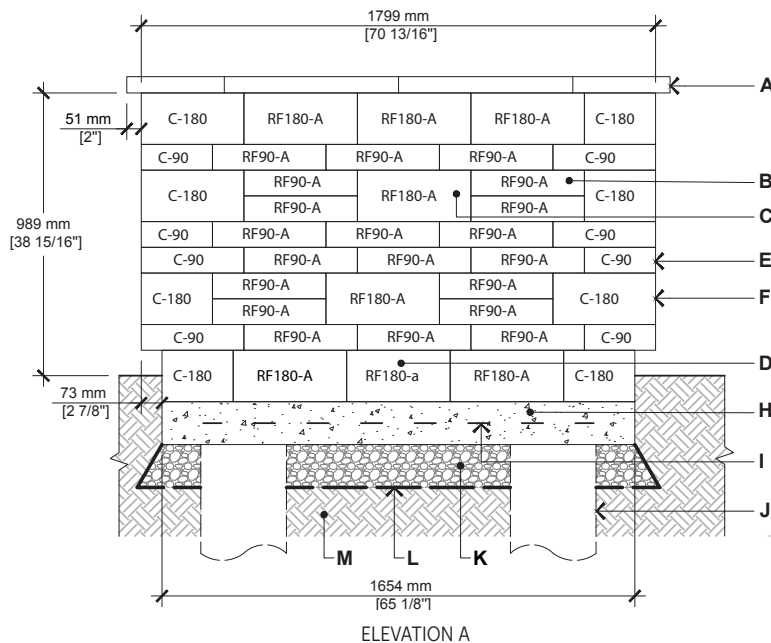
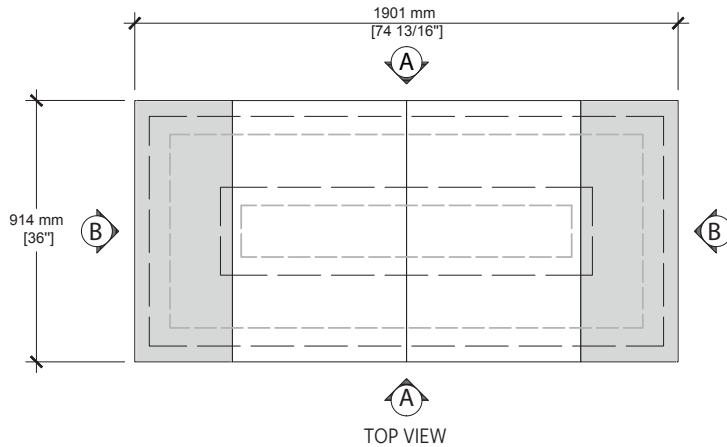

- A.** YORK COUNTER TOP 24" × 36" × 2 1/4" (CUT ON FIELD AS REQUIRED)
- B.** RAFFINATO 90 mm UNIT (A) - LONG FACE EXPOSED (SHOWN WITH UPPERCASE LETTER)
- C.** RAFFINATO 180 mm UNIT (A) - LONG FACE EXPOSED (SHOWN WITH UPPERCASE LETTER)
- D.** RAFFINATO 180 mm UNIT (A) - SHORT FACE EXPOSED (SHOWN WITH LOWERCASE LETTER)
- E.** RAFFINATO 90 mm PILLAR UNIT
- F.** RAFFINATO 180 mm PILLAR UNIT
- G.** RAFFINATO UNIT CUT ON FIELD AS REQUIRED
- H.** CAST IN PLACE CONCRETE SLAB 4350 psi (30 MPa), 5" (125 mm) THICK
- I.** 4X4-4/4 (102X102-MW25.8XMW25.8) WELDED WIRE MESH AND/OR REBAR AS PER SITE CONDITIONS
- J.** 12" (300 mm) DIA. CONCRETE PILLAR, AS PER LOCAL CODE
- K.** 3/4" (20 mm) CLEAN STONE
6" (150 mm) THICK MIN. AS PER SITE CONDITIONS
- L.** GEOTEXTILE
- M.** NATURAL SOIL OR COMPACTED BACKFILL

QUANTITY OF MATERIALS REQUIRED

- York Counter top 24" × 36" × 2 1/4": **4**
- Raffinato 90 mm wall unit: **48 A**
- Raffinato 180 mm wall unit: **22 A**
- Raffinato 90 mm pillar unit: **16**
- Raffinato 180 mm pillar unit: **16**

NOTE: Appliances and utilities may vary for each project and are not shown on this drawing. This drawing is shown for inspiration only and surplus or shortage of materials may result. It is the user's responsibility to verify for the quantity of materials required. Secure the blocks using a heat resistant concrete adhesive. The installer must ensure that the installation and use of the grill island comply with local regulations and code requirements. Concrete pillars extending to frost line may be required as per local code. Check your local building code before installing.

INSTALLATION GUIDE

GRILL ISLAND - RAFFINATO POLISHED 90 mm & 180 mm

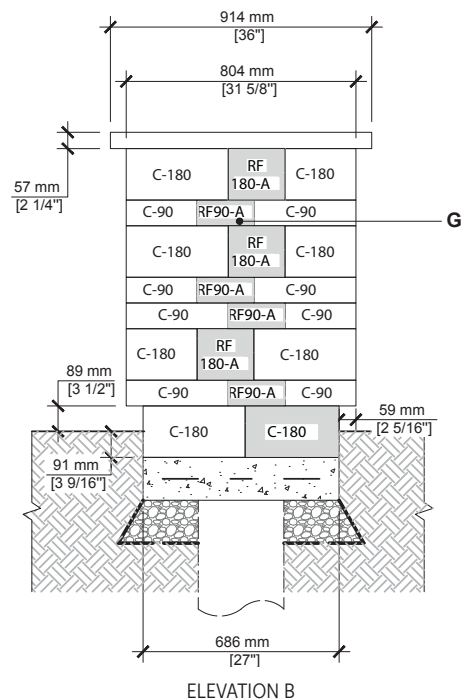
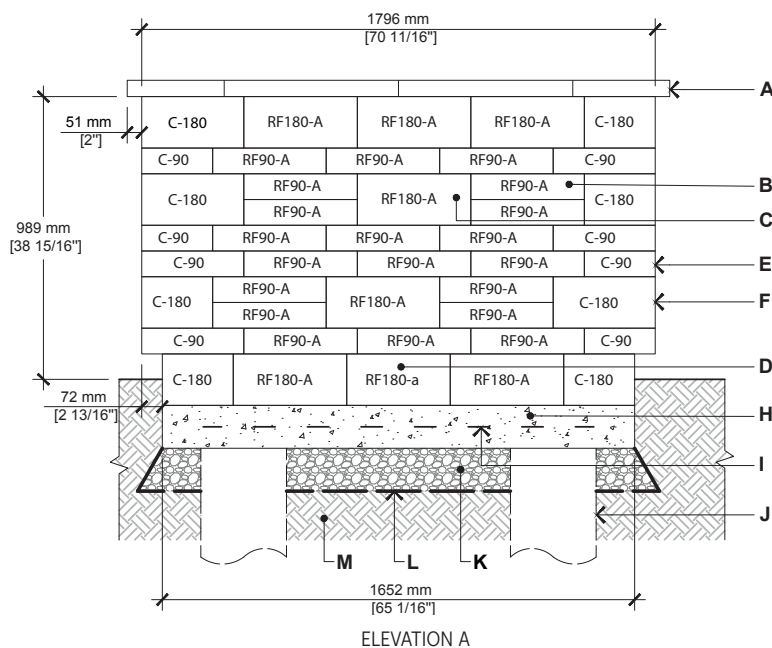
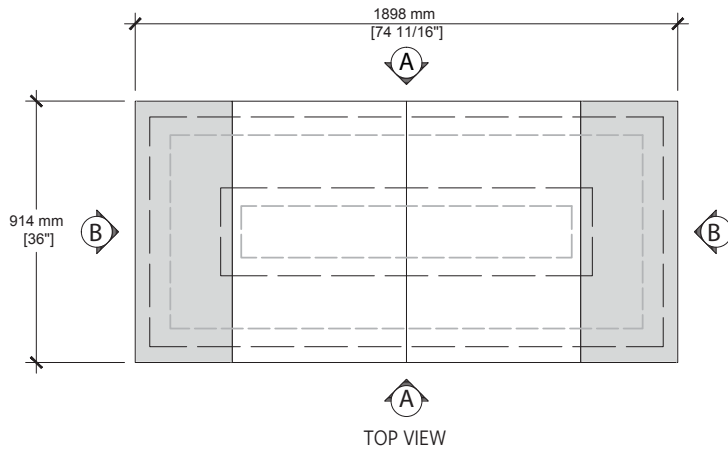

- A.** YORK COUNTER TOP 24" × 36" × 2 1/4" (CUT ON FIELD AS REQUIRED)
- B.** RAFFINATO 90 mm UNIT (A) - LONG FACE EXPOSED (SHOWN WITH UPPERCASE LETTER)
- C.** RAFFINATO 180 mm UNIT (A) - LONG FACE EXPOSED (SHOWN WITH UPPERCASE LETTER)
- D.** RAFFINATO 180 mm UNIT (A) - SHORT FACE EXPOSED (SHOWN WITH LOWERCASE LETTER)
- E.** RAFFINATO 90 mm PILLAR UNIT
- F.** RAFFINATO 180 mm PILLAR UNIT
- G.** RAFFINATO UNIT CUT ON FIELD AS REQUIRED
- H.** CAST IN PLACE CONCRETE SLAB 4350 psi (30 MPa), 5" (125 mm) THICK
- I.** 4X4-4/4 (102X102-MW25.8XMW25.8) WELDED WIRE MESH AND/OR REBAR AS PER SITE CONDITIONS
- J.** 12" (300 mm) DIA. CONCRETE PILLAR, AS PER LOCAL CODE
- K.** 3/4" (20 mm) CLEAN STONE
6" (150 mm) THICK MIN. AS PER SITE CONDITIONS
- L.** GEOTEXTILE
- M.** NATURAL SOIL OR COMPACTED BACKFILL

QUANTITY OF MATERIALS REQUIRED

- York Counter top 24" × 36" × 2 1/4" : **4**
- Raffinato 90 mm wall unit: **48 A**
- Raffinato 180 mm wall unit: **22 A**
- Raffinato 90 mm pillar unit: **16**
- Raffinato 180 mm pillarunit: **16**

NOTE: Appliances and utilities may vary for each project and are not shown on this drawing. This drawing is shown for inspiration only and surplus or shortage of materials may result. It is the user's responsibility to verify for the quantity of materials required. Secure the blocks using a heat resistant concrete adhesive. The installer must ensure that the installation and use of the grill island comply with local regulations and code requirements. Concrete pillars extending to frost line may be required as per local code. Check your local building code before installing.

PLEASE REFER TO P.4 FOR THE CORRECT USE AND LIMITATIONS OF PROVIDED TECHNICAL INFORMATION.