

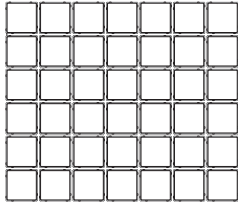

INDUSTRIA 150 SERIES

DESCRIPTION: Paver **TEXTURE:** HD² Polished

PALLET OVERVIEW - 150x150



NOTES

See page 62 to 64 for more technical information.

See page 30 for more information about applications.

All 150 Series items are on order only.
Minimum order required: 2,000 sq. ft.
Deposit required

Specifications per pallet		Imperial	Metric
150x150	Cubing	71.20 ft²	6.62 m ²
	Approx. Weight	3 357 lbs	1 523 kg
	Number of rows	7	
	Coverage per row	10.17 ft ²	0.95 m ²
	Linear coverage per row	20.67 lin. ft	6.30 lin. m

Unit dimensions	in	mm	Units/pallet
	Height	3 7/8	
Width	5 7/8	150	
Length	5 7/8	150	

01 | Linear pattern

100% - 150x150

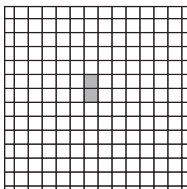

02 | Linear pattern

100% - 150x150

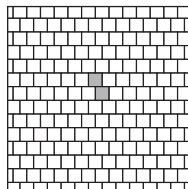

24 | Modular pattern

80% - 450x300 | 20% - 150x150

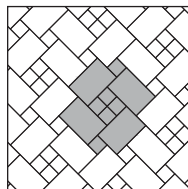

Patterns are for design inspiration only. The installer is responsible to calculate & purchase the correct amount of material.

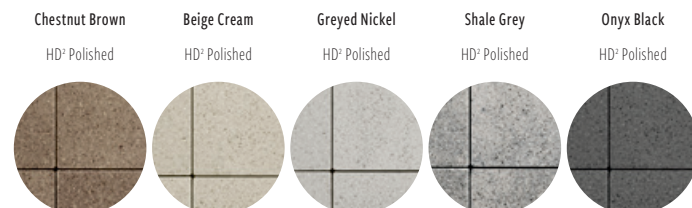

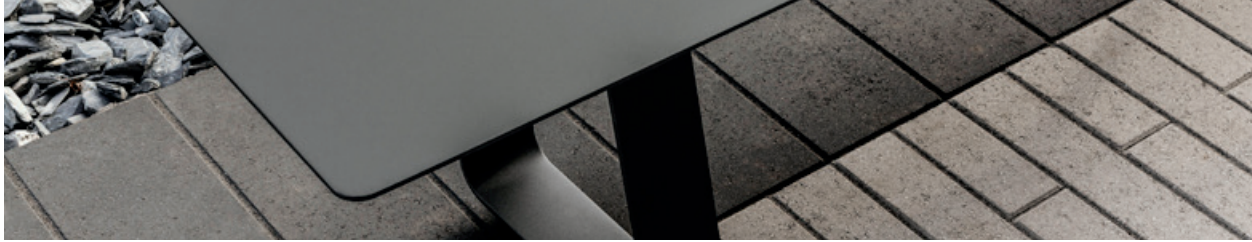

INDUSTRIA 200 SERIES

DESCRIPTION: Paver TEXTURE: HD² Polished

PALLET OVERVIEW - 200x200

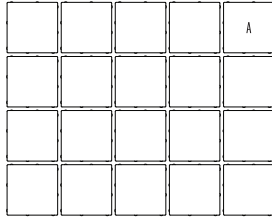

PALLET OVERVIEW - 200x400

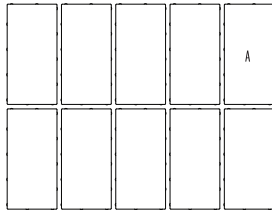

NOTES

See page 62 to 64 for more technical information.

See page 30 for more information about applications.

All 200 Series items are on order only.
Minimum order required: 2,000 sq. ft.
Deposit required

Specifications per pallet		Imperial	Metric
200x200	Cubing	60.28 ft²	5.60 m ²
	Approx. Weight	2 848 lbs	1 292 kg
	Number of rows	7	
	Coverage per row	8.61 ft ²	0.80 m ²
	Linear coverage per row	13.12 lin. ft	4 lin. m

Unit dimensions		in	mm	Units/pallet
	Height	3 7/8	98	140 units
	Width	7 7/8	200	
	Length	7 7/8	200	

Specifications per pallet		Imperial	Metric
200x400	Cubing	60.28 ft²	5.60 m ²
	Approx. Weight	2 848 lbs	1 292 kg
	Number of rows	7	
	Coverage per row	8.61 ft ²	0.80 m ²
	Linear coverage per row	Depth 6.56 lin. ft Length 13.12 lin. ft	2 lin. m 4 lin. m

Unit dimensions		in	mm	Units/pallet
	Height	3 7/8	98	70 units
	Width	7 7/8	200	
	Length	15 3/4	400	

05 | Linear pattern

50% - 200x200 | 50% - 200x400

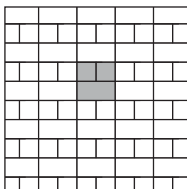

06 | Linear pattern

60% - 200x200 | 40% - 200x400

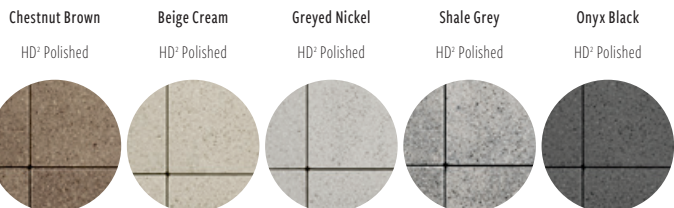
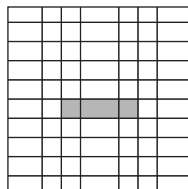

Patterns are for design inspiration only. The installer is responsible to calculate & purchase the correct amount of material.



INDUSTRIA 300 SERIES

DESCRIPTION: Paver TEXTURE: HD² Polished

PALLET OVERVIEW - 300x100

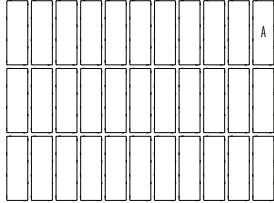

PALLET OVERVIEW - 300x150

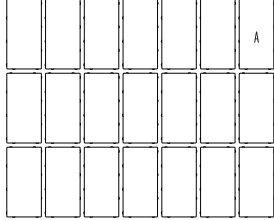

NOTES

See page 62 to 64 for more technical information.

See page 30 for more information about applications.

300 Series HD² Polished and HD² Granitex are made-to-order, minimum order of 500 sq. ft. Deposit required. HD² Smooth is in stock with shorter lead times.

Specifications per pallet		Imperial	Metric
300x100	Cubing	74.59 ft²	6.93 m ²
	Approx. Weight	3 412 lbs	1 548 kg
	Number of rows	7	
	Coverage per row	10.66 ft ²	0.99 m ²
	Linear coverage per row	Depth 32.48 lin. ft Length 10.83 lin. ft	9.90 lin. m 3.30 lin. m

Unit dimensions		in	mm	Units/pallet
	Height	3 7/8	98	231 units
	Width	11 13/16	300	
	Length	3 15/16	100	

Specifications per pallet		Imperial	Metric
300x150	Cubing	71.20 ft²	6.62 m ²
	Approx. Weight	3 288 lbs	1 491 kg
	Number of rows	7	
	Coverage per row	10.17 ft ²	0.95 m ²
	Linear coverage per row	Depth 20.67 lin. ft Length 10.33 lin. ft	6.30 lin. m 3.15 lin. m

Unit dimensions		in	mm	Units/pallet
	Height	3 7/8	98	147 units
	Width	11 13/16	300	
	Length	5 7/8	150	

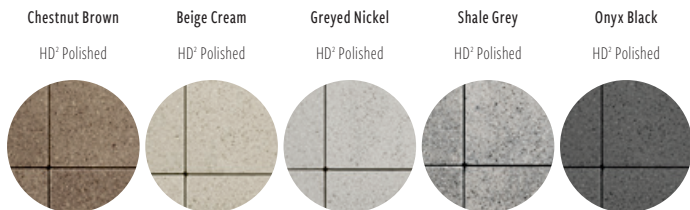

09 | Linear pattern

75% - 300x300 | 25% - 300x100

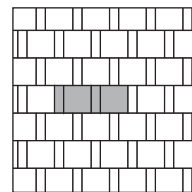

10 | Linear pattern

60% - 300x150 | 40% - 300x100

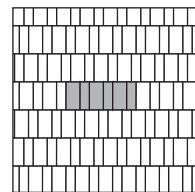

Patterns are for design inspiration only. The installer is responsible to calculate & purchase the correct amount of material.



INDUSTRIA 300 SERIES

DESCRIPTION: Paver TEXTURE: HD² Polished

PALLET OVERVIEW - 300x300

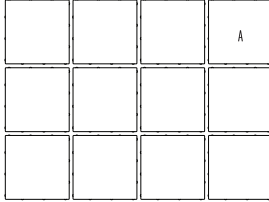

PALLET OVERVIEW - TRIANGLE

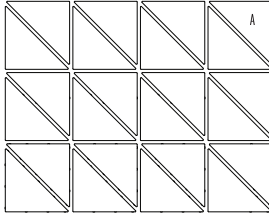

NOTES

See page 62 to 64 for more technical information.

See page 30 for more information about applications.

300 Series HD² Polished and HD² Granitex are made-to-order, minimum order of 500 sq. ft. Deposit required. HD² Smooth is in stock with shorter lead times.

Specifications per pallet		Imperial	Metric
300x300	Cubing	81.38 ft²	7.56 m ²
	Approx. Weight	3 725 lbs	1 690 kg
	Number of rows	7	
	Coverage per row	11.63 ft ²	1.08 m ²
	Linear coverage per row	11.81 lin. ft	3.60 lin. m

Unit dimensions		in	mm	Units/pallet
	Height	3 7/8	98	84 units
	Width	11 13/16	300	
	Length	11 13/16	300	

Specifications per pallet		Imperial	Metric
TRIANGLE	Cubing	81.38 ft²	7.56 m ²
	Approx. Weight	3 743 lbs	1 698 kg
	Number of rows	7	
	Coverage per row	11.63 ft ²	1.08 m ²
	Linear coverage per row	11.81 lin. ft	3.60 lin. m

Unit dimensions		in	mm	Units/pallet
	Height	3 7/8	98	168 units
	Width	11 13/16	300	
	Length	11 13/16	300	

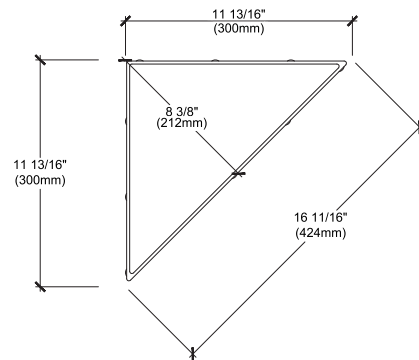

01 | Linear pattern

100% - 300x300

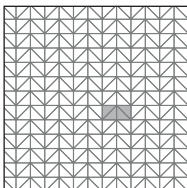

03 | Linear pattern

100% - 300x300

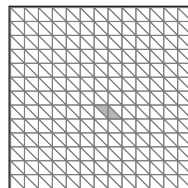

Patterns are for design inspiration only. The installer is responsible to calculate & purchase the correct amount of material.

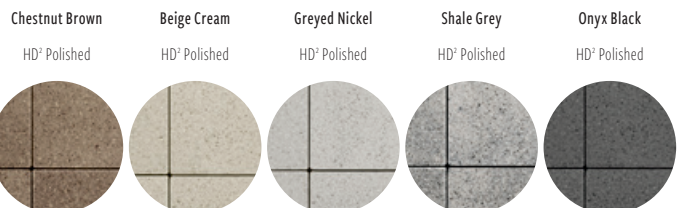



INDUSTRIA 450 SERIES

DESCRIPTION: Paver TEXTURE: HD² Polished

PALLET OVERVIEW - 450X100

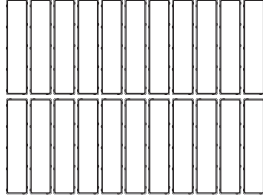

PALLET OVERVIEW - 450X150

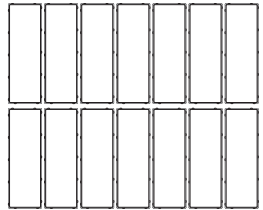

PALLET OVERVIEW - 450X300

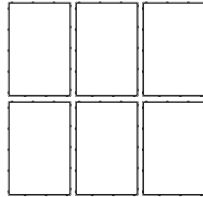

NOTES

See page 62 to 64 for more technical information.

See page 30 for more information about applications.

All 450 Series items are on order only. Minimum order required: 2,000 sq. ft. Deposit required

13 | Herringbone pattern

100% · 450x100

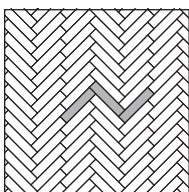

14 | Herringbone pattern

60% · 450x150 | 40% · 450x100

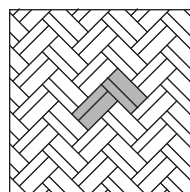

Patterns are for design inspiration only. The installer is responsible to calculate & purchase the correct amount of material.

Specifications per pallet		Imperial	Metric
450x100	Cubing	74.59 ft²	6.93 m ²
	Approx. Weight	3 516 lbs	1 595 kg
	Number of rows	7	
	Coverage per row	10.66 ft ²	0.99 m ²
Linear coverage per row	Depth	32.48 lin. ft	9.90 lin. m
	Length	7.22 lin. ft	2.20 lin. m



Unit dimensions	in	mm	Units/pallet
Height	3 7/8	98	154 units
Width	3 15/16	100	
Length	17 1/16	450	

Specifications per pallet		Imperial	Metric
450x150	Cubing	71.20 ft²	6.62 m ²
	Approx. Weight	3 357 lbs	1 523 kg
	Number of rows	7	
	Coverage per row	10.17 ft ²	0.95 m ²
Linear coverage per row	Depth	20.67 lin. ft	6.30 lin. m
	Length	6.89 lin. ft	2.10 lin. m



Unit dimensions	in	mm	Units/pallet
Height	3 7/8	98	98 units
Width	5 7/8	150	
Length	17 1/16	450	

Specifications per pallet		Imperial	Metric
450x300	Cubing	61.03 ft²	5.67 m ²
	Approx. Weight	2 883 lbs	1 308 kg
	Number of rows	7	
	Coverage per row	8.72 ft ²	0.81 m ²
Linear coverage per row	Depth	8.86 lin. ft	2.70 lin. m
	Length	5.91 lin. ft	1.80 lin. m

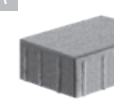

Unit dimensions	in	mm	Units/pallet
Height	3 7/8	98	42 units
Width	11 13/16	300	
Length	17 1/16	450	

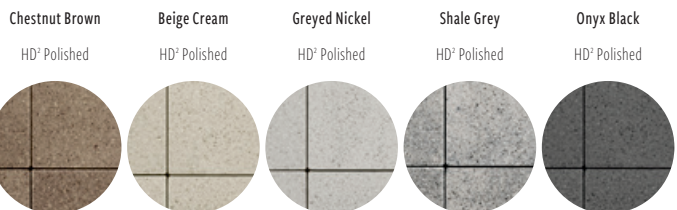



INDUSTRIA 600 SERIES

DESCRIPTION: Paver TEXTURE: HD² Polished

PALLET OVERVIEW - 600x100

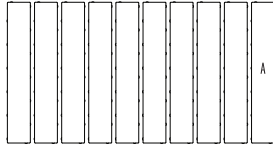

PALLET OVERVIEW - 600x200

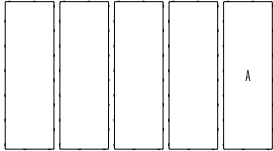

PALLET OVERVIEW - 600x300

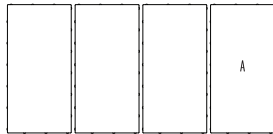

NOTES

See page 62 to 64 for more technical information.

See page 30 for more information about applications.

Industria 600x100, 600x200 and 600x300 are made to order (2,000 sq.ft. min. required). Deposit required.

*For this application, it is recommended that this product be installed on a concrete base as designed by a local Engineer.

Specifications per pallet		Imperial	Metric
600x100	Cubing	45.21 ft²	4.20 m²
	Approx. Weight	2 112 lbs	958 kg
	Number of rows	7	
	Coverage per row	6.46 ft²	0.60 m²
Linear coverage per row	Depth	19.69 lin. ft	6 lin. m
	Length	3.28 lin. ft	1 lin. m

Unit dimensions		in	mm	Units/pallet
Height	3 ⁷ / ₈	98	70 units	
Width	23 ⁵ / ₈	600		
Length	3 ¹⁵ / ₁₆	100		

Specifications per pallet		Imperial	Metric
600x200	Cubing	45.21 ft²	4.20 m²
	Approx. Weight	2 145 lbs	973 kg
	Number of rows	7	
	Coverage per row	6.46 ft²	0.60 m²
Linear coverage per row	Depth	9.84 lin. ft	3 lin. m
	Length	3.28 lin. ft	1 lin. m

Unit dimensions		in	mm	Units/pallet
Height	3 ⁷ / ₈	98	35 units	
Width	23 ⁵ / ₈	600		
Length	7 ⁷ / ₈	200		

Specifications per pallet		Imperial	Metric
600x300	Cubing	54.25 ft²	5.04 m²
	Approx. Weight	2 567 lbs	1 164 kg
	Number of rows	7	
	Coverage per row	7.75 ft²	0.72 m²
Linear coverage per row	Depth	7.87 lin. ft	2.40 lin. m
	Length	3.94 lin. ft	1.20 lin. m

Unit dimensions		in	mm	Units/pallet
Height	3 ⁷ / ₈	98	28 units	
Width	23 ⁵ / ₈	600		
Length	11 ¹³ / ₁₆	300		

27 | Linear pattern

65% - 600x200 | 35% - 600x100

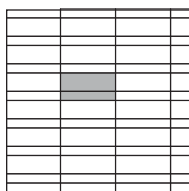

28 | Linear pattern

50% - 600x300 | 50% - 600x600

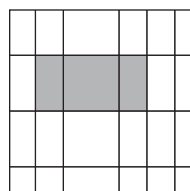

Patterns are for design inspiration only. The installer is responsible to calculate & purchase the correct amount of material.

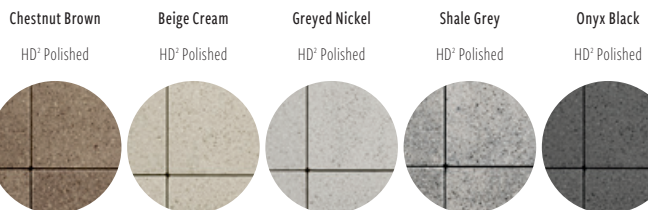



INDUSTRIA 600 SERIES

DESCRIPTION: Paver and Slab **TEXTURE:** HD² Polished

PALLET OVERVIEW - 100x600x600 PAVER



PALLET OVERVIEW - 60x600x600 SLAB



NOTES

100x600x600 PAVER:

See page 62 to 64 for more technical information.

*For this application, it is recommended that this product be installed on a concrete base as designed by a local Engineer.

60x600x600 SLAB:

See page 35 to 37 for more technical information.

See page 30 for more information about applications.

Industria 100x600x600 is made to order (2,000 sq.ft. min. required). Deposit required.

Industria 60x600x600 HD² Granitex and HD² Polished are made to order (500 sq.ft. min. required). Deposit required.

Industria 60x600x600 HD² Smooth is in stock with shorter lead times.

Specifications per pallet		Imperial	Metric
PAVER 100x600x600	Cubing	54.25 ft ²	5.04 m ²
	Approx. Weight	2 556 lbs	1 159 kg
	Number of rows	7	
	Coverage per row	7.75 ft ²	0.72 m ²
	Linear coverage per row	3.94 lin. ft	1.20 lin. m

Unit dimensions		in	mm	Units/pallet
	Height	3 7/8	98	14 units
	Width	23 5/8	600	
	Length	23 5/8	600	

Specifications per pallet		Imperial	Metric
SLAB 60x600x600	Cubing	54.25 ft ²	5.04 m ²
	Approx. Weight	1 555 lbs	705 kg
	Number of rows	7	
	Coverage per row	7.75 ft ²	0.72 m ²
	Linear coverage per row	3.94 lin. ft	1.20 lin. m

Unit dimensions		in	mm	Units/pallet
	Height	2 5/16	58	14 units
	Width	23 5/8	600	
	Length	23 5/8	600	

29 | Linear pattern

100% - 600x600

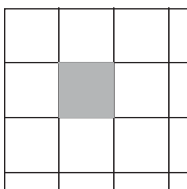

30 | Linear pattern

100% - 600x600

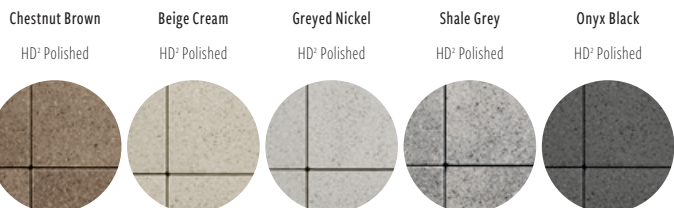
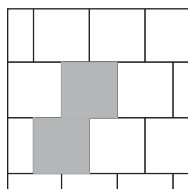

Patterns are for design inspiration only. The installer is responsible to calculate & purchase the correct amount of material.



INDUSTRIA 900 SERIES

DESCRIPTION: Paver TEXTURE: HD² Polished

PALLET OVERVIEW - 900x300



PALLET OVERVIEW - 900x600

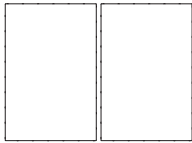

PALLET OVERVIEW - 900x900

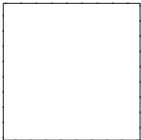

NOTES

See page 62 to 64 for more technical information.

See page 30 for more information about applications.

900 Series HD² Polished and HD² Granitex are made-to-order, minimum order of 500 sq. ft. Deposit required. HD² Smooth is in stock with shorter lead times.

*For this application, it is recommended that this product be installed on a concrete base as designed by a local Engineer.

Specifications per pallet		Imperial	Metric
900x300	Cubing	81.38 ft²	7.56 m ²
	Approx. Weight	3 821 lbs	1 733 kg
	Number of rows	7	
	Coverage per row	11.63 ft ²	1.08 m ²

Unit dimensions		in	mm	Units/pallet
	Height	3 ⁷ / ₈	98	28 units
	Width	35 ⁷ / ₁₆	900	
	Length	11 ¹³ / ₁₆	300	

Specifications per pallet		Imperial	Metric
900x600	Cubing	81.38 ft²	7.56 m ²
	Approx. Weight	3 839 lbs	1 741 kg
	Number of rows	7	
	Coverage per row	11.63 ft ²	1.08 m ²

Unit dimensions		in	mm	Units/pallet
	Height	3 ⁷ / ₈	98	14 units
	Width	35 ⁷ / ₁₆	900	
	Length	23 ⁵ / ₈	600	

Specifications per pallet		Imperial	Metric
900x900	Cubing	61.00 ft²	5.67 m ²
	Approx. Weight	2 893 lbs	1 312 kg
	Number of rows	7	
	Coverage per row	8.72 ft ²	0.81 m ²

Unit dimensions		in	mm	Units/pallet
	Height	3 ⁷ / ₈	98	7 units
	Width	35 ⁷ / ₁₆	900	
	Length	35 ⁷ / ₁₆	900	

42 | Linear pattern

60% - 900x300 | 40% - 900x600

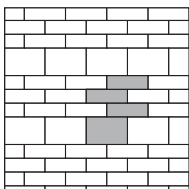

44 | Herringbone pattern

70% - 900x600 | 30% - 900x300

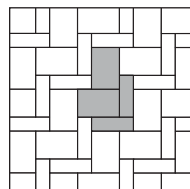

Patterns are for design inspiration only. The installer is responsible to calculate & purchase the correct amount of material.

